

Addon H-MCU

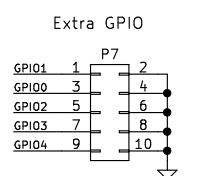

Input LEDs
I2S, Opt2, Opt1, Cx2, Cx1

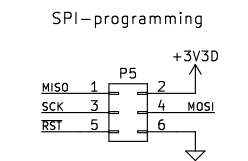
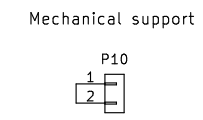
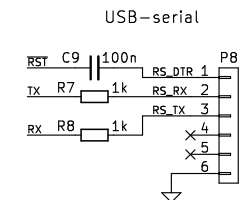
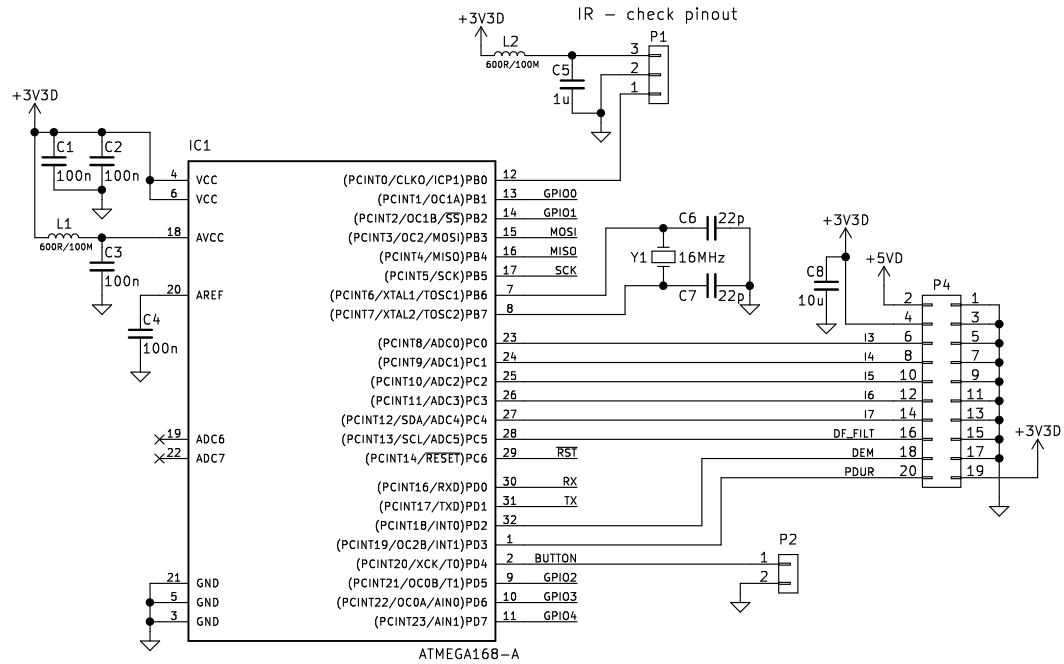
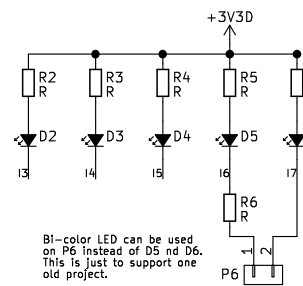

De-emphasis

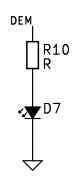

Phase detector update rate

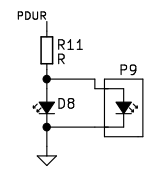

Digital filter roll-off

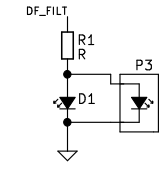

Tomi Nihtilä
 Sheet: /
 File: Addon_H-MCU_v10A.sch
Title: Addon H-MCU
 Size: A4 Date: 2016-04-26
 KiCad E.D.A. kicad 4.0.1-stable

Rev: v1.0A
 Id: 1/1